

**Bistró**

Brochure - Ficha Técnica

BISTRÓ posee un diseño amable y moderno.

Gracias a su simplicidad, resulta ideal para utilizarse en diferentes ámbitos. Además, la amplia gama de colores permite variadas combinaciones estéticas. Todos los espacios cobran vida con BISTRÓ. Esta silla también está disponible en tándem, cajera y en versión tapizada.

La flexibilidad es la clave de este producto. El usuario puede moverse libremente y asegurar posiciones ergonómicas naturales, que facilitan un correcto flujo sanguíneo.

La fuerte estructura de cuatro patas se presenta en gris mate, negro mate o cromada y posee regatones especiales de apilamiento.





### ESPECIFICACIONES TÉCNICAS

Certificado por:  
 EN 13761:2002: "Sillas de Visita - Normas Generales de Seguridad"  
 EN 1728:2000: "Normas Dimensionales y de Durabilidad"

Garantía: 2 años

#### BASE 4 PATAS

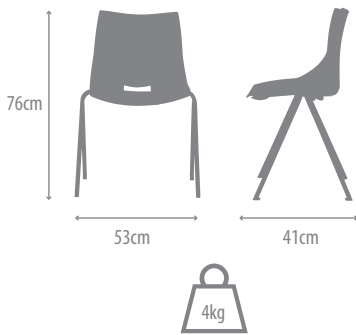

#### BASE ESTRELLA

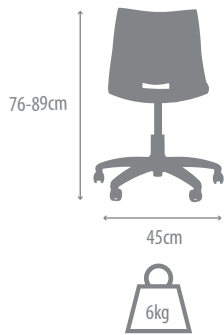

#### TANDEM

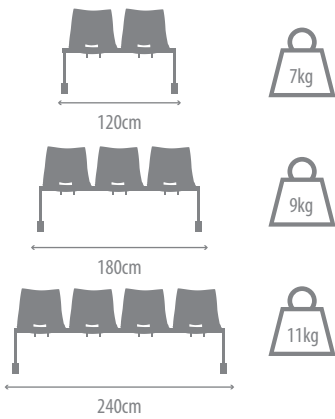

#### BASE



#### COLOR (A PEDIDO)



**COLORES & MATERIALES**

**TELA (VERSIÓN TAPIZADA)**



01 NEGRO

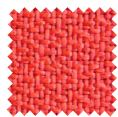

02 ROJO

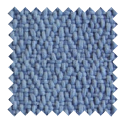

03 CELESTE



04 GRIS



05 VERDE

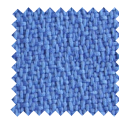

06 AZUL

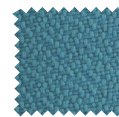

07 PETROLEO



08 MAIZ

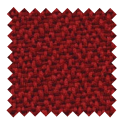

09 BORDO



10 BEIGE



11 NARANJA



12 VIOLETA



13 GRIS PERLA

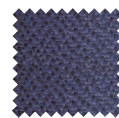

14 AZUL OSCURO

**ECOCUERO**



15 NEGRO

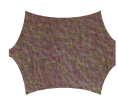

16 CHOCOLATE

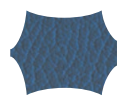

17 AZUL MARINO



18 BEIGE



19 BLANCO

**COLOR DE CASCO POLIPROPILENO**



NEGRO



BLANCO



ORANGE



LIME



AQUA



ROJO



AZUL